

NanoDrive Series

40W 24VDC 0-10V Dimmable CV LED Driver



NanoDrive

40W 24VDC 0-10V Dimmable CV LED Driver



Description

The NanoDrive 0-10V Dimmable Driver offers a super compact metal case with a built-in junction box. Dimming is smooth down to 1% with any standard 0-10V dimmer switch or system. With high efficiency performance, these drivers are designed to power any 24VDC LED strip. Its IP65 rating and universal input voltage make it the perfect choice for any application.



Features

- 0-10V Dimmable
- Flicker-Free Dimming to 1%
- Super compact metal case
- Built-in wiring compartments with knock-out
- Universal 120-277VAC Input Voltage
- 90% efficiency
- IP65 rated for indoor and outdoor use
- Class 2 Output
- Current limit over load protection

Applications

- LED Strip
- LED Tape
- LED Cove
- LED Linear
- Puck Lights

Dimming

Dimming Protocol:	0-10V
Min. Dimming Level:	1%
Dimming Curve:	Linear
Current Consumption:	0.2mA Max Source / Sinc
Dimming type:	PWM (1000Hz)

Specifications

Part Number	NANO-40W-24DC
Max Power:	40W
Input Voltage:	120-277VAC
Input Frequency:	50-60Hz
Input Current:	1.33A max
Inrush Current:	<50A
Output Voltage:	24VDC
Output Current:	1.66A
Load Regulation:	+/-1%
Turn on delay time:	0.45s
Efficiency@ full load:	85%
Operating Ambient temp:	-13°F - 104°F
Over Temp Protection:	Yes / Hiccup Mode
Over Load Protection:	Yes / Current Limit
Short Circuit Protection:	Yes / Hiccup Mode
Warranty:	6-Year
IP Rating:	IP65 1.433lbs
Weight: Dimensions (W x H x L):	1.97" x 1.45" x 8.77"

NanoDrive

40W 24VDC 0-10V Dimmable CV LED Driver

Wiring Diagrams

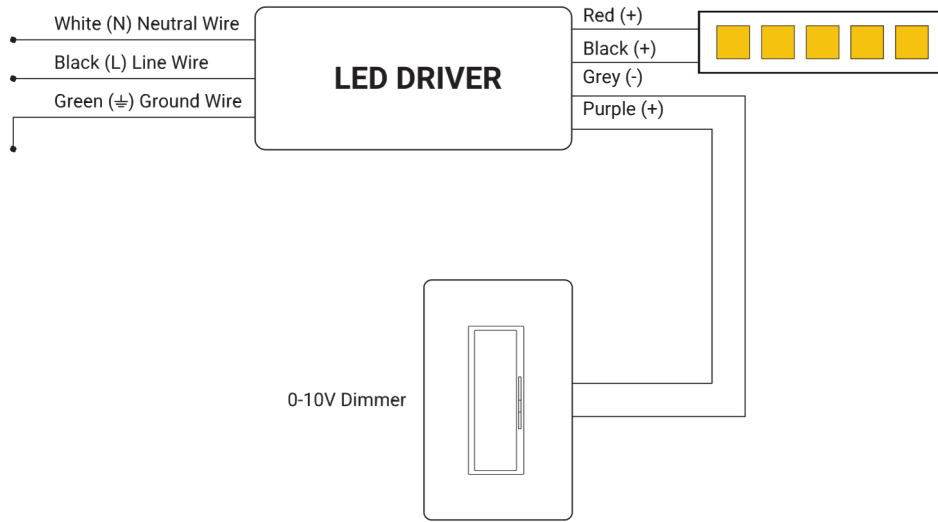

Mechanical Diagrams

